

CONNECTOR

FOR MAVIC 2

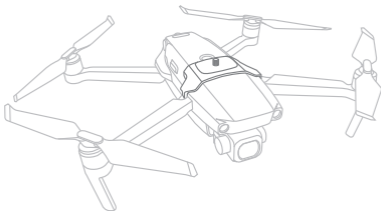

PGYTECH

包装清单 In The Box



说明书 x 1

User Manual x 1



转接座 x 1

Connector x 1

基本参数 Product Parametres

产品名称: 转接座

产品型号: P-HA-038

主要材质: ABS, 不锈钢

Product Name: Connector For MAVIC 2

Item Number: P-HA-038

Main Material: ABS, Stainless Steel

安装示意图 Instruction

1/4 英寸螺纹
1/4 inch thread

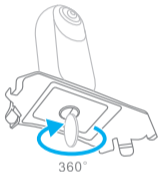
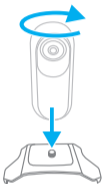

- 1、将配件安装在转接座上，调整好拍摄角度。
Install the accessory on the adapter then adjust the shooting angle.

- 2、用工具拧紧螺丝。
Tighten the screw with a tool.

注：不建议在飞行器上调整配件角度。

Notes: It is not advised to adjust the angle of the accessory on the drone.

安装示意图 Instruction

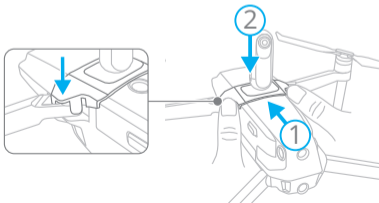
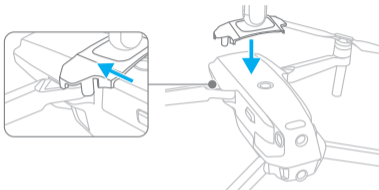

拆卸示意图 Disassembly

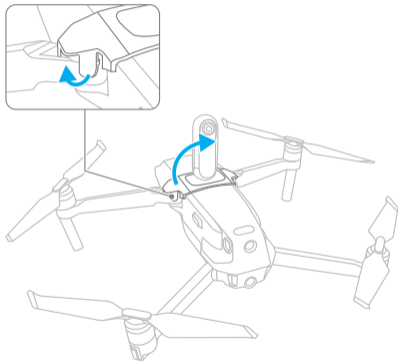

扩展功能 Extended Function

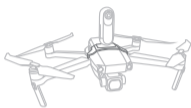

注：使用此配件时请勿开启SPORT模式，负载重量不超过160g。

Notes: Do not turn on SPORT mode when using this accessory, the load weight is not allowed to exceed 160g.



RoHS

Designed by PGYTECH
MADE IN CHINA
www.pgy-tech.com

Tutorial



使用说明